

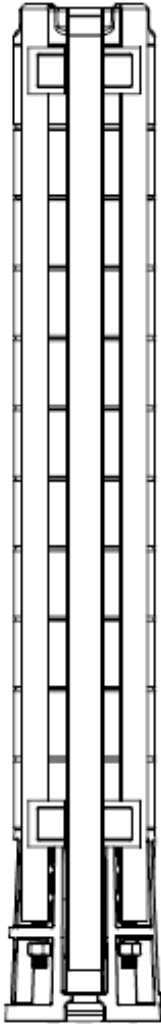

Franklin Electric

SUBMERSIBLE PUMPS OWNER'S MANUAL





BEFORE INSTALLING PUMP, BE SURE TO READ THIS OWNER'S MANUAL CAREFULLY.

INSPECT THE SHIPMENT

Examine the pump when it is received to be sure there has been no damage in shipping. Should any be evident, report it immediately to the transportation company and ask to have it inspected. Check the pump nameplate to ensure you have received the correct pump unit.

READ AND FOLLOW SAFETY INSTRUCTIONS

 This is the safety alert symbol. When you see this symbol on your pump or in this manual, look for one of the following signal words and be alert to the potential for personal injury:

 **DANGER** warns about hazards that will cause serious personal injury, death or major property damage if ignored.

 **WARNING** warns about hazards that **can** cause serious personal injury, death or major property damage if ignored.

 **CAUTION** warns about hazards that **will or can** cause minor personal injury or major property damage if ignored.

The label **NOTICE** indicates special instructions, which are important but not related to hazards.

 **WARNING**



Hazardous voltage. Can shock, burn or cause death.

Ground motor before connecting to power supply. Disconnect power before working on pump, motor or tank.

Carefully read and follow all safety instructions in this manual and on pump.

Keep safety labels in good condition.

Replace missing or damaged safety labels.

WARNING: This equipment must not be used by children or persons with reduced physical, sensory or mental abilities, or lacking in experience and expertise, unless supervised or instructed. Children may not use the equipment, nor may they play with the unit or in the immediate vicinity.

SUBMERSIBLE PUMPS

CONTENTS

A. Inspection-Receipt of Equipment 3

B. General Information 3

C.Suitability of the Well..... 4

D.Installation-Site & Support Equipment 5

E.Pump to Motor Assembly 6

F.Pump/Motor Installation 7

G.Accessories with Installation 8

H.Operational Checkup 8

I. Troubleshooting 9

J. Maintenance and Service..... 9

K. Disposal..... 9

A. INSPECTION-RECEIPT OF EQUIPMENT

Examine equipment at the time of receipt. Handle the pump, cable, and motor carefully. This is very important because of the precise alignment of the assembly and the vulnerability of the cable. Report any **damages** or **shortages** immediately to the freight carrier agent and make notes on the freight bill of lading. This will facilitate a satisfactory and prompt processing of a claim adjustment.

Delivery

These submersible pumps are supplied in their own original packing in which they should remain until installation.

Avoid the pump to be bent when it is not packed, since this may cause the misalignment and the damage of the pump itself.

The loose data plate supplied with the pump should be fixed close to the electric control equipment.

The pump shall not be exposed to unnecessary impacts and crashes.

Storage and Handling

Storage Temperature:

Pump: from -20°C to +60°C

The pump should not be exposed to direct sunlight.

If the pump has not been packed, it shall be stored horizontally, adequately supported, or vertically, to prevent the misalignment of the pump. During storage, the pump can be supported as shown in Fig. 1.

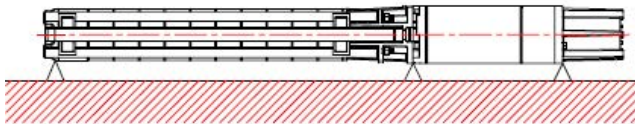

Fig 1.

If the pump is not used in vertical position, both the pump side and the motor side must be supported. Note that the centre of gravity will vary according to the pump type.

B. GENERAL INFORMATION

The submersible pump unit comprises a submersible pump assembly directly-coupled to a submersible electric motor. The connecting bracket accommodates the coupling between the pump and motor shafts and also serves as the water intake passage.

The pump unit is suspended in the well by the riser pipe, and the electric power is taken down from the well head to the motor by the submersible cable, which is secured at intervals to the riser pipe.

Please read the manufacturer's separate instruction manual for the motor, and keep it for future reference.

This pump has been developed according to the most advanced and recent technology, as well as in compliance with the regulations in force. Moreover, the pump is subject to a permanent quality control.

These operating instructions are intended to help you better understand the pump operation and to show you its possible applications.

The manual contains important information necessary for reliable and profitable operation. Compliance with the operating instructions is of vital importance to ensure the reliability and a long service life of the pump, as well as to avoid any accident risk due to improper use.

This pump must not be operated beyond the limit values quoted in the technical specification. Any indication concerning the nature, the density, the temperature, and the rate flow of the pumped liquid, as well as the rotation speed, the pressure and the power of the motor shall be observed. Any other instruction contained in this manual or in the documentation enclosed to the agreement shall be observed as well.

The rating plate bears the type series, the main operation data, and the serial number. Please, quote this information in all request of intervention or assistance, and when ordering spare parts.

Safety regulations

This manual contains essential instructions that must be observed during installation, operation and maintenance. Therefore, this operating handbook must be read and understood both by the person in charge of assembling the machine and by all qualified personnel appointed by the responsible for installation to perform its operation. These operating instructions must always be available on use site of the machine.

The submersible pumps are multistage pumps working with counterclockwise rotation direction (observing from the delivery side) directly coupled to special submersible motors (according to NEMA standards).

Pump identification code

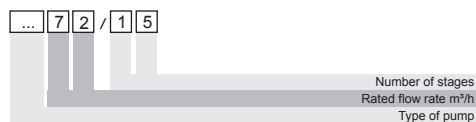

Applications

These submersible pumps are designed for a wide range of applications, such as the supply of water to private homes, water systems and industries.

These pumps are necessary in case of lowering of the groundwater level, as well as for pressure increase. Submerge the pump completely under the water level both if it is installed horizontally and vertically.

Pumped liquids

Pumped liquids must be clean, compatible with pump components and materials, without solid particles or fibres. The maximum sand content in the water must not exceed 50 g/m³. A greater sand content in the water reduces the service life of the pump and increases the risk of blocking. When pumping liquids with a density higher than that of water, motors with correspondingly higher outputs must be used.

Marking of coded instructions within the manual The safety instructions contained in this manual, whose inobservance might cause hazards to person, are marked with the general hazard sign, i.e.:



Hazard Sign

Risks due to inobservance of safety instructions

Inobservance of safety instructions may cause physical and material damages, as well as environmental pollution. Non-compliance with safety instructions will also lead to the complete loss of any warranty right.

In particular, the inobservance of the above mentioned instructions may for example result in:

- failure of main machine/unit functions;
- failure of maintenance procedures;
- hazard of electrical, mechanical or chemical nature.

Safety regulations

All safety instructions contained in this manual shall be observed, as well as any other national regulation on accident prevention, and any internal regulation on the use of machineries and on occupational safety.

Safety instructions for control, maintenance, and operation works

The person in charge must verify that all maintenance, inspection and installation works are performed by qualified and authorised personnel. Before performing these works, the personnel must be aware of the content of this manual.

All interventions on the machines must be carried out only during total standstill of the mentioned machines. Strictly observe the shutdown procedure described in this manual.

Pumps conveying fluids hazardous to health must be decontaminated.

Immediately after completion of work, all safety and protective devices must be re-installed and/or re-enabled.

Modification and manufacture of Spare parts

Any reconstruction or alteration of the machine must be performed by the manufacturer before being carried out. Original spare parts and accessories supplied by the manufacturer ensure safety. The manufacturer is not in any case liable for damages due to the use of non-original spare parts!

C. SUITABILITY OF THE WELL

Submersible pumps, as well as all water pumps, are designed to handle clean, cool, clear water. Water from an undeveloped well often contains excessive amounts of sand, dirt, and other abrasives which can cause damage to the pump.

Install the pump in a well which has already been properly developed with a test pump.

The test pump also provides a means to match the capacity and setting of the pump to the yield of the well. If the pump removes water at a higher rate than the well produces, the drawdown will be excessive and this will cause the pump to pump air and result in damage to the pump or motor.

The well must be deep enough so that the pump suction is at least 10 feet below the expected drawdown level. The inside diameter of the well casing must be large enough to allow lowering the unit into the well without damage to the power cable and the splice between the power cable and the motor leads. Check that the well is large enough to allow installation of the pump at the required depth. Keep the bottom of the motor at least 10 feet from the bottom of the well, particularly where there is a history of sand in the well. Do not install the pump or motor within the perforations in the well casing unless the well size permits the installation of a flow sleeve over unit to ensure an adequate flow of water over the motor for cooling purposes.



DO NOT INSTALL THE UNIT WITH THE MOTOR RESTING ON THE BOTTOM, OR CLOSER THAN 10 FEET FROM THE BOTTOM OF THE WELL.

Submersible motors require a minimum cooling flow. Please refer to the motor manufacturer's applications, installation, maintenance manual (AIM manual) for motor cooling requirements.

D. INSTALLATION-SITE & SUPPORT EQUIPMENT



The pump is suitable for both vertical and horizontal installation, however, the pump should never be installed inclined downwards, see Fig. 2.

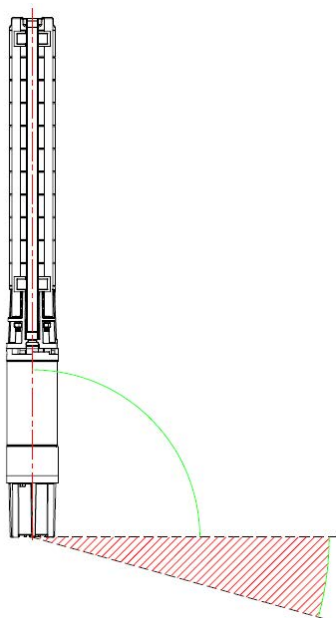

Fig 2.

Note: During operation, the suction support must always be completely submerged. In special conditions, it may be necessary to submerge the pump even deeper, depending on the operation conditions of the pump, as well as on temperature and NPSH values.

Equipment & Material Required:

The material and equipment necessary for the installation of the pump will vary with the pump size and type of installation. The following is a general list of needed tools and supplies.

Materials: Anti-galling lubricant, thread compound, lubricating oil, grease.

Tools & Instruments: Tripod with chain blocks, or rig with power hoist, pipe clamps, megger, pipe wrenches, and mechanical tools.

Be sure that the equipment is strong enough to lift the total weight of the pump and motor assembly, riser pipe, and water in the riser pipes.

FOUNDATION

Construct a concrete foundation which must be RIGID, LEVEL, and of adequate STRENGTH to support the complete weight of the pump, motor, column, plus the weight of the water pumping through it without exceeding the permissible bearing pressure for the subsoil.

Support the riser pipe at the well head with a well seal, surface plate, or other adapter which seals the well in accordance with local regulations. Make provision for a conduit to carry the power cable into the well in accordance with local regulations.

Diameter of Pump/Motor

Check in the technical catalog the maximum diameter of the pump and the pump with motor. Verify the borehole with an inside calliper to ensure unobstructed passage.

Check valve on the delivering piping

The pump is equipped with an embedded check valve in the delivery opening. However, it is recommended, especially if the pump directly feeds a distribution network subject to pressure, to install another check valve on the delivery piping at no more than 10 meters from the minimum well level. (If this latter is not known, use the delivery opening as minimum level). Its presence reduces hydraulic shocks due to starts and stops.

ELECTRICAL CONNECTIONS



General remarks

The electrical connections should be carried out by an authorised electrician according to the regulations in force.

Supply voltage, current and $\cos \phi$ are quoted on the motor plate that has to be kept within the electrical panel.

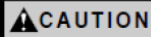

THE MOTOR MUST BE EARTHED AND CONNECTED TO THE ELECTRIC PANEL.

Verification of Rotation Direction

When the pump has been connected to the power supply, establish the current direction of rotation as follows:

1. Start the pump and control the head provided with gate valve not fully closed.
2. Stop the pump and interchange two of the phase connections.
3. Start the pump and repeat step 1. with the gate valve in the same position.
4. Stop the pump.

Compare the results obtained after performing steps 1 and 3. The correct connection is the one that gives the highest head.

Note: The pump must not be started until the suction support has been completely submerged.

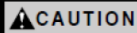

BEFORE STARTING ANY WORK ON THE PUMP OR ON THE MOTOR, MAKE SURE THAT THE POWER SUPPLY HAS BEEN DISABLED AND THAT IT CANNOT BE ACCIDENTALLY SWITCHED ON.

RISER PIPE

Make up the riser pipe from random lengths of threaded and coupled pipe, and make arrangements to secure it at the well by a well seal, surface plate, or other adapter. Take great care to keep pipes clean and free from pebbles, scale, and thread chips. Tighten each joint securely as recommended by the AIM manual.

If the pump is already coupled to the delivery piping and you use a chain pipe wrench, tighten the pump, holding it only by the delivery opening.

The threaded pipes must be connected in such a way as to support the unscrewing action due to the starting and stopping of the pump.

The thread of the pipe, which has to be screwed into the pump, should not be longer than the thread of the pump. After screwing the pipe into the delivery opening, tighten the screw assembled to avoid the loosening of the first section of the pipe.

Cable fitting

Use cable clips every 3 meters to fix the cable to the support rope or to the delivery pipe.

Use plastic cable clips as shown in Fig. 3.

Once the cable has been fastened, cut off the remaining part of the clip.

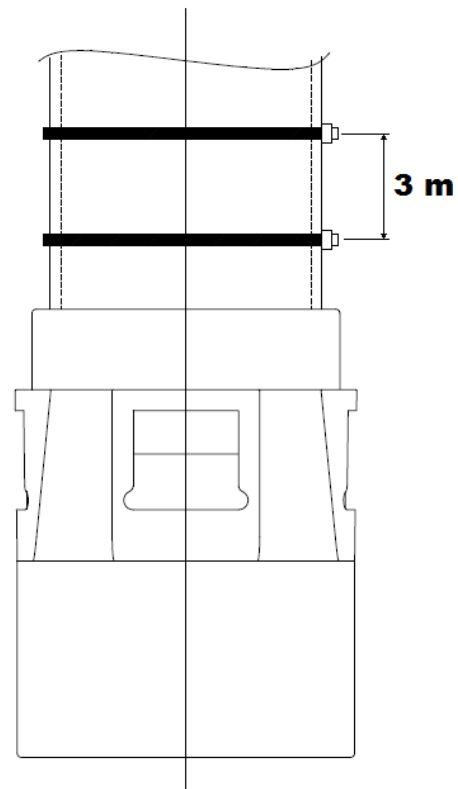

Fig 3.

In the case that the tube is plastic, it must leave the electric cable and the cable support not in tension to prevent the elongation of the tube, due to the weight of the water contained in it, tearing the electric cable.

When flanged pipes are used, the cable clips must be positioned before and after each flange.

CHECK VALVES

It is recommended that one or more check valves always be used in submersible pump installations. If the pump does not have a built-in check valve, an inline check valve should be installed in the discharge line within 25 feet of the pump and below the drawdown level of the water supply. For deeper settings, check valves should be installed per the manufacturer's recommendations. More than one check valve may be required, but more than the recommended number of check valves should not be used.

E. PUMP TO MOTOR ASSEMBLY

Pump should be assembled to the motor at the installation site. Always assemble pump to motor vertically to reduce strain on pump coupling and motor shaft. Assembling the pump and motor horizontally or on angle may result in damage to the pump shaft, coupling or motor shaft.

Place the pump on the motor in order that they are positioned along the same axis and insert the motor shaft in the pump shaft joint: the coupling must not be forced. Tighten the screws or the nuts that diagonally fix the pump-motor flanges with a driving torque as quoted in the following table.

Motor type	Screw	Driving torque Nm
Motor 4"	M8	18
Motor 6"	M12	100
Motor 8"	M16	200

F. PUMP/MOTOR INSTALLATION

Thread the first length of riser pipe into the pump discharge and raise the pump and pipe into a vertical position over the motor. Refer to the AIM manual for installation recommendations. Be careful not to drag the pump and motor assembly along the ground, or let it strike other objects while placing the assembly over the well.

Lower the pump about 10 feet into the well and fasten the cable to the riser pipe to prevent tangling and damage.

Continue to add lengths in the same manner until the required pump setting is reached. Secure the cable to the riser pipe at regular intervals.

Lowering of the pump

Verify that the well is not clogged along its total length. Lower the pump into the well, paying attention not to damage the electric cable.

Note: Do not lower the pump by means of the electric cable.

Installation depth

The dynamic water level must always be above the suction support of the pump, see paragraph 3.1 *Positioning Limits* and Fig. 4.

The minimum safety margin shall be 1 meter.

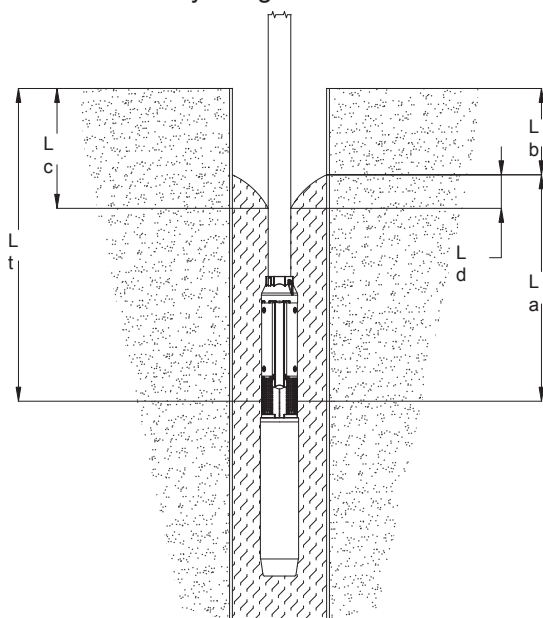

Fig. 4

CAUTION

TAKE GREAT CARE TO PREVENT DAMAGE TO THE CABLE DURING INSTALLATION.

La: Minimum installation depth (suggested: minimum 1 mt).

Lb: Static water level

Lc: Dynamic water level

Ld: Difference between static and dynamic level

Lt: Installation depth

Block the delivery pipe with proper hangers on the well head.

Loosen the support rope and fix it to the groundwork.

6. START-UP

When the pump has been installed and submerged, it can be started with the gate valve closed to 1/3.

Check the direction of rotation as described in section 4.2 *Verification of Rotation Direction*.

If there are impurities in the water, the gate valve should be opened gradually until the water becomes clearer. The pump should not be stopped until the water is completely clean again, since otherwise the pump parts and the non-return valve may be damaged. If the pump flow rate is higher than that of the well, the use of a protection device against dry operation is recommended.

Without any protection against dry operation, the water level falls under the suction support and the pump sucks air. In the long term, this causes damages due to poor cooling and lubrication.

Place the sanitary well seal, surface plate or other adapter on the last length of riser pipe and pass the submersible cable through the opening provided. Then attach the discharge tee or elbow to the riser pipe. Lower the riser pipe to its final position and tighten the well seal or other device to support the installation in the well.

INITIAL START-UP & PERFORMANCE CHECK

Check the pump and well performance before making the final connection to the discharge system.

1. Install a pressure gauge and gate valve on the end of the pipe. Close the valve.
2. Start the pump, check the pressure developed against the closed valve. If the pressure is substantially less than expected (please allow for the depth of the water level), the pump may be running backward. To change the rotation of a three-phase motor, interchange any two leads.

3. Open the gate valve to produce a low flow. Open the gate valve gradually until full flow is achieved.
4. Use a clamp-on amp meter to read the current, which should approximate the full-load current given on the motor nameplate, but must not exceed the service factor rating of the motor. The service factor varies with the model of the motor. Consult the factory if insufficient information is given about Service Factor performance.

Check that the currents in the individual phases of a three-phase system are approximately equal. Where there is considerable difference between them, change all three connections at the starter as shown below (so that rotation remains the same) to obtain the most consistent readings.

Then subtract the average of the readings from the highest. The difference, expressed as a percent of the average, must not exceed 5%. Note that the highest reading must not exceed the maximum permissible for the motor.

EXAMPLE:

Phase 1	54.0 amp
Phase 2	55.0 amp
Phase 3	60.0 amp
Average:	56.3 amp
% Unbalance = $\frac{(60 - 56.3) \times 100}{56.3}$	
	= $\frac{3.7 \times 100}{56.3}$ = 6.6%

⚠ WARNING

FAILURE TO GROUND THE UNIT PROPERLY CAN RESULT IN SERIOUS OR FATAL SHOCK. REFER TO ELECTRICAL CODE REQUIREMENTS.

Should the unbalance exceed 5%, consult the power company to improve the voltage balance between the incoming lines

5. Use a voltmeter to verify the voltage at the starter while the pump is running. The voltage must be within 10% of the motor rating, and the maximum variation of any phase of a three-phase system from the average should not exceed 1%.
6. Continue to run the pump until the drawdown of the water in the well becomes stable. Should the water level drop to the pump intake to admit air, use one or more of the following methods to protect installation.

⚠ CAUTION

NEVER RUN THE PUMP UNLESS IT IS COMPLETELY SUBMERGED IN WATER.

- (a) Install additional riser pipe to place pump lower in the well if possible.
- (b) Use a gate valve in the discharge line to throttle the pump output to suit the yield of the well.
- (c) Install floatless liquid level control.
- (d) Use a pressure switch with a low water protection or a separate low-water cutout switch. Neither of these devices give as reliable protection as a floatless liquid level control and both require careful application.
- (e) Replace the pump with a smaller unit to avoid over-pumping the well.

G. ACCESSORIES WITH INSTALLATION

RELIEF VALVE

Always install a relief valve if the pump is capable of developing pressures in the discharge system greater than the pressure ratings of individual components. The relief valve must be large enough to handle the pump output at the relief pressure.

H. OPERATIONAL CHECKUP

The most reliable indications of the condition of a submersible pump are:

- (a) Current drawn by the motor.
- (b) Insulation resistance of the installation below ground.

As the pump wears, the motor current increases, until eventually the overloads trip to protect the motor. The overload is designed to protect the motor in an emergency situation; proper care of a submersible installation should include periodic check-ups to avoid interruptions in the water supply. Use a megger to check the motor's insulation resistance every six months.

Record the insulation resistance and the running current for future reference. When the insulation resistance falls below 10 megohms, check it frequently for further deterioration and pull the pump when the resistance falls to 0.5 megohm or below.

When pulling the pump, either coil the cable on a reel or raise it from the ground to dry. Check the insulation again when the cable and splices are dry. If the insulation value between the line and motor casing increases to 50 megohms or more, isolate the fault in the cable or the splice and make the necessary repairs. However, if the insulation reading remains low, disconnect the motor from the cable and check the motor separately. Should the motor be defective, check the pump end for wear and obtain a replacement for either the motor alone, or the pump unit, as necessary.

I. TROUBLESHOOTING

1. Disconnect power unless required for testing.
2. Have electrical testing done by a qualified electrician.
3. Most problems occur above ground. Remove pump only as a last resort.

When troubleshooting or servicing the pump, use all precautions for the voltages involved.

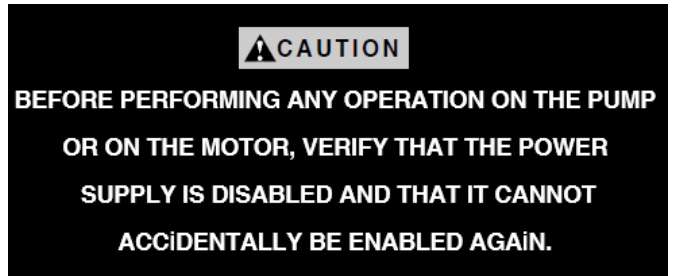

K. DISPOSAL

This product or parts of it must be disposed using the local public or private waste collection service.

Problem	Possible Cause	Remedy
Unit fails to start	1. Electrical trouble	Check power source: starter and reset
		Check resistance: cable and motor
		Call dealer or electrician
	2. Pump sandlocked	Call dealer: pull pump and clean
Pump fails to deliver water	1. Insufficient well yield: water level has dropped	Reset pump - lower into well Restrict flow to yield
	2. Clogged intake screen	Pull pump
	3. Air lock in pump	Start and stop pump several times allowing 15 min. between starts and stops.
	4. Leak in discharge	Raise pipe until leak is found
Reduced pump output	1. Screen or pump partly plugged	Pull pump and clean
	2. Insufficient well yield	Check water level: lower pump if permissible
	3. Worn pump - excessive wear due to abrasives	Replace worn parts
	4. Low voltage	Call electrician
	5. Three-phase unit running backward	Reverse rotation
Overload trips	1. Worn pump or pump bound by sand	Pull pump and clean or replace worn parts
	2. Electrical troubles	Call dealer or electrician
Unit cycles too frequently	1. Pressure switch out of adjustment	Readjust to correct setting or replace
	2. Leaks in service line	Locate and correct
	3. Check valve leaking	Replace
	4. Water logged tank	Check tank for leaks. Be sure fittings are functioning properly

J. MAINTENANCE AND SERVICE

The pumps are maintenance-free.

All pumps are easy to service.

Use the Service Kits and the special tools for maintenance. The Service Manual is available upon request.

Field Installation

1. Place the motor in a vertical position.

NOTICE:

A motor and pump should always be coupled in a vertical position to ensure correct alignment and prevent any chance of bending or damaging to either shaft.

2. Clean the pump and motor shafts of debris.
3. Check to ensure the shafts rotate freely.
4. Generously lubricate the motor shaft splines.

NOTICE:

Use a non-toxic FDA-approved waterproof grease – (Mobile FM102, Texaco CYGNU2661, or equivalent).

5. Install the coupling on the pump.
6. Lightly tighten one of the coupling set screws.
7. Align the pump such that the motor leads will be correctly positioned with the lead notch in the pump's mounting flange.
8. Lower the pump so the mounting holes are aligned and the pump's weight is supported by the motor face.
9. **VERIFY THE PUMP SHAFT WAS LIFTED 1/8" DURING THE PREVIOUS STEP.** This is critical to ensure the impellers are correctly positioned in the pump bowls.
10. Install and tighten the motor and pump mounting bolts.
11. Align the coupling splines with the motor shaft splines and pull the coupling down as far as it will slide on the pump shaft.

NOTICE:

When the coupling is correctly positioned, only a small amount (~ 1/8") of the end of the motor splines will be visible.

12. Apply Loctite 243 and firmly tighten the set screws in the coupling.

INSTALLATION COMPLETE

LIMITED WARRANTY*

Except as set forth in an Extended Warranty, for twelve (12) months from the date of installation, but in no event more than twenty-four (24) months from the date of manufacture, Franklin hereby warrants to the purchaser ("Purchaser") of Franklin's products that, for the applicable warranty period, the products purchased will (i) be free from defects in workmanship and material at the time of shipment, (ii) perform consistently with samples previously supplied and (iii) conform to the specifications published or agreed to in writing between the purchaser and Franklin. This limited warranty extends only to products purchased directly from Franklin. If a product is purchased other than from a distributor or directly from Franklin, such product must be installed by a Franklin Certified Installer for this limited warranty to apply. This limited warranty is not assignable or transferable to any subsequent purchaser or user.

a. THIS LIMITED WARRANTY IS IN LIEU OF ALL OTHER WARRANTIES, WRITTEN OR ORAL, STATUTORY, EXPRESS, OR IMPLIED, INCLUDING ANY WARRANTY OF MERCHANTABILITY OR FITNESS FOR A PARTICULAR PURPOSE. PURCHASER'S SOLE AND EXCLUSIVE REMEDY

FOR FRANKLIN'S BREACH OF ITS OBLIGATIONS HEREUNDER, INCLUDING BREACH OF ANY EXPRESS OR IMPLIED WARRANTY OR OTHERWISE, UNLESS PROVIDED ON THE FACE HEREOF OR IN A WRITTEN INSTRUMENT MADE PART OF THIS LIMITED WARRANTY, SHALL BE FOR THE PURCHASE PRICE PAID TO FRANKLIN FOR THE NONCONFORMING OR DEFECTIVE PRODUCT OR FOR THE REPAIR OR REPLACEMENT OF NONCONFORMING OR DEFECTIVE PRODUCT, AT FRANKLIN'S ELECTION. ANY FRANKLIN PRODUCT WHICH FRANKLIN DETERMINES TO BE DEFECTIVE WITHIN THE WARRANTY PERIOD SHALL BE, AT FRANKLIN'S SOLE OPTION, REPAIRED, REPLACED, OR A REFUND OF THE PURCHASE PRICE PAID. Some states do not allow limitations on how long an implied warranty lasts, therefore, the limitations and exclusions relating to the products may not apply.

b. WITHOUT LIMITING THE GENERALITY OF THE EXCLUSIONS OF THIS LIMITED WARRANTY, FRANKLIN SHALL NOT BE LIABLE TO THE PURCHASER OR ANY THIRD PARTY FOR ANY AND ALL (i) INCIDENTAL EXPENSES OR OTHER CHARGES, COSTS, EXPENSES (INCLUDING COSTS OF INSPECTION, TESTING, STORAGE, OR TRANSPORTATION) OR (ii) DAMAGES, INCLUDING CONSEQUENTIAL, SPECIAL DAMAGES, PUNITIVE OR INDIRECT DAMAGES, INCLUDING, WITHOUT LIMITATION, LOST PROFITS, LOST TIME AND LOST BUSINESS OPPORTUNITIES, REGARDLESS OF WHETHER FRANKLIN IS OR IS SHOWN TO BE AT FAULT, AND REGARDLESS OF WHETHER THERE IS OR THERE IS SHOWN TO HAVE BEEN A DEFECT IN MATERIALS OR WORKMANSHIP, NEGLIGENCE IN MANUFACTURE OR DESIGN, OR A FAILURE TO WARN.

c. Franklin's liability arising out of the sale or delivery of its products, or their use, whether based upon warranty contract, negligence, or otherwise, shall not in any case exceed the cost of repair or replacement of the product and, upon expiration of any applicable warranty period, any and all such liability shall terminate.

d. Without limiting the generality of the exclusions of this limited warranty, Franklin does not warrant the adequacy of any specifications provided directly or indirectly by a purchaser or that Franklin's products will perform in accordance with such specifications. This limited warranty does not apply to any products that have been subject to misuse (including use in a manner inconsistent with the design of the product), abuse, neglect, accident or improper installation or maintenance, or to products that have been altered or repaired by any person or entity other than Franklin or its authorized representatives.

e. Unless otherwise specified in an Extended Warranty authorized by Franklin for a specific product or product line, this limited warranty does not apply to performance caused by abrasive materials, corrosion due to aggressive conditions or improper voltage supply.

f. With respect to motors and pumps, the following conditions automatically void this limited warranty:

1. Mud or sand deposits which indicate that the motor has been submerged in mud or sand.
2. Physical damage as evidenced by bent shaft, broken or chipped castings, or broken or bent thrust parts.
3. Sand damage as indicated by abrasive wear of motor seals or splines.
4. Lightning damage (often referred to as high voltage surge damage).
5. Electrical failures due to the use of non-approved overload protection.
6. Unauthorized disassembly.



106089101
Rev. 6
06-



Franklin Electric

9255 Coverdale Road
Fort Wayne, IN. 46809
Tel: 260-824-2900
Fax: 260-824-2909
www.franklinwater.com